

Towards Energy-Autonomous Wake-up Receiver using Visible Light Communication

Joyce Sariol Ramos^{*}, Ilker Demirkol^{*,†}, Josep Paradells^{*,†}, Daniel Vössing[§], Karim M. Gad[§], Martin Kasemann[§]

^{*}Department of Telematics Engineering, Universitat Politècnica de Catalunya, Barcelona, Spain

[†]Fundacio i2CAT, Barcelona, Spain

[§]Department of Microsystems Engineering – IMTEK, University of Freiburg, 79110 Freiburg, Germany

E-mail: joyce.sariol@alu-etsetb.upc.edu, {ilker.demirkol, josep.paradells}@entel.upc.edu, {daniel.voessing, karim.mohamed}@imtek.uni-freiburg.de, kasemann@ak-labs.de

Abstract— The use of Visible Light Communication (VLC) in wake-up communication systems is a potential energy-efficient and low-cost solution for wireless communication of consumer electronics. In this paper, we go one step further and propose the use of visible light both for wake-up communication and energy harvesting purposes, with the final objective of an energy-autonomous wake-up receiver module. We first present the details and the design criteria of this novel system. We then present the results of evaluation of design criteria such as solar panel and capacitor type choices. To evaluate the performance of the developed wake-up system with energy-autonomous receiver system, we perform realistic indoor scenario tests, analyzing the effect of varying distances, angles, and light intensities as well as the effect of presence of interfering lights.

Keywords—Energy-Autonomous system, Wake-up receiver, Visible Light Communication (VLC), Solar panel, Light Emitor Diode (LED), Energy harvesting.

I. Introduction

Due to the large number of wireless consumer communication systems envisioned in the future, energy-efficient operation of these devices has been a crucial target of the research community, along with reducing the radio pollution caused and developing scalable solutions. The idle power consumption of the networked devices has been observed to be as high as 66% of the overall power consumption [1]. Use of wake-up radio systems is a promising solution in this context, which reduces the idle power of the devices substantially.

A wake-up radio system is responsible for alerting a target device whenever a data communication is necessary. For this, wake-up radio transmitter sends a wake-up call which is detected by the wake-up radio receiver that is in charge of triggering the target device through an interruption. In this way, wake-up radio systems allow on-demand access to the consumer devices, while keeping the wireless devices in deep-sleep mode as long as possible. Such on-demand access also reduce the overhead (synchronization, control packet communication, etc.) caused by other solutions for energy efficient communications, such as the duty-cycled operation, i.e., where a periodic sleep-listen schedule is used [2].

Visible Light Communication (VLC) has been a recent communication technology alternative, finding its way in the

consumer communication area, through the applications such as indoor localization using mobile phone cameras, or consumer products such as the ones from pureLiFi company. In the meantime, the use of visible light for wake-up communication purposes has been demonstrated in a recent work [3].

Our main goal in this paper is to extend this prior work to achieve an *energy-autonomous* wake-up receiver module that uses Visible Light Communication (VLC). By the use of a solar panel as both VLC communication receiver and energy-harvester, we design an energy-autonomous wake-up receiver system, which is crucial for the energy-efficient operation of battery-constrained consumer devices such as the Internet of Things (IoT) devices.

In this paper, we present the details of and evaluate several design criteria for this novel system, by performing experiments to study the individual system components' effect on the performance in realistic indoor scenarios. As an example, the solar panel on the receiver side converts light energy into electrical energy, delivered to both to an ultra-low power consumption device and to a capacitor [10], which will be used to feed the system when the light source is off. Therefore it is important to choose carefully the solar panel to be used in terms of energy efficiency. We also present the feasibility tests of the system performed in realistic indoor environments and lighting conditions, evaluating the effect of receiver-transmitter distance and angles, and interferences from other light sources. Through these tests, we show that the proposed system achieves reasonable operational distances and is resilient to different light interference conditions.

The rest of the paper is structured as follows. Section II gives an overview of the state of the art on the work topic. Section III presents a general overview of the system. Section IV describes design tests and shows the results. In Section V we provide operational environment tests and the corresponding results. In Section VI we present the conclusions along with the potential future work.

II. Related Work

There have been numerous studies on the wake-up systems, covering different methods of implementation and media options. These systems are usually built on radio triggered approaches, typically using a different channel than

This work was supported in part by the Spanish Government's Ministerio de Economía y Competitividad through projects TEC2012-32531, RYC-2013-13029 and FEDER.

the main radio to send wake-up signals. Wake-up systems can also be classified as active or passive, according to how they are powered [4]. In active systems, the receiver is powered by a battery or by sharing the battery of the attached node. In passive systems, the receiver is fed by harvesting energy from the environment, for instance using the transmitted RF signal.

Examples of active wake-up systems using light are proposed in [5] and [6]. The first solution transmits the signal using free space optical communication, and the receiver uses photo diodes to detect the signal. This approach is considered for indoor environments; as it requires line of sight and a highly directional communication. An interesting feature is the very low power that it needs to function using Texas Instruments devices. The receiver consumes just $317\mu\text{W}$ when receiving and the transmitter reaches a range of 15m by using just 16.5mW. The solution proposed in [6] uses infrared frequency and it is built for use in indoor tasks such as positioning, identification, and waking up external hardware, e.g., sensor nodes. As in [5], the power consumption is very low; in waiting mode the receiver consumes $4\mu\text{A}$, and depending on the transmitter signal intensity, the wake-up signals can be detected at up to 30m distance.

A passive receiver approach is proposed in [7], in which a piezoelectric device is used to harvest energy and feed a radio wake-up receiver. To the best of the authors' knowledge, this paper is the first to present and evaluate a wake-up system using visible light both for energy harvesting and wake-up communication purposes, paving way to completely energy-autonomous wireless devices.

III. The VLC WuRx System

A block diagram of the VLC wake-up communication system proposed is shown in Figure 1. The transmitter is composed of a programmable WSN node that controls the modulation of a LED, a LED driver module, and a LED light. The WSN node generates the wake-up signal with the address of the device to be contacted, which enables an addressable wake-up. The generated signal varies the current feeding the LED through the circuit of the LED drive module.

On the receiver side, an indoor solar panel receives the light signal and converts it into electric current. At this phase, the electric signal has two functions: charge a capacitor and carry the sent information to the demodulator. The capacitor feeds the demodulator when the light sources are off, which can be used for example to feed the MCU of the receiver for certain operations. The solar panel and the capacitor relieves the need of any other power source for wake-up purposes, providing totally energy-autonomous wake-up receiver component. In this way, the attached consumer device can be put to deep-sleep for very long times, eliminating the energy

waste of the standby/idle modes.

The electric signal is demodulated as OOK (On-Off Keying) signal at the demodulator, which extracts the original information and delivers it to the pattern correlator. The pattern correlator compares the demodulated signal with the address of the receiver, and in case of a match, a wake-up interrupt is generated for the attached consumer device. Subsequently, this device with the matching address starts its operation, for example, receiving an incoming data transmission, performing sensor measurements, etc.

IV. System Components and Design Tests

There are certain conditions and requirements to take into account when developing a VLC system in indoor environments. Obstacles may block the line of sight, or the nodes may be in darkness for a long time when light sources are off. Moreover, the devices should have small footprints, should achieve feasible wake-up distances and should be energy-efficient consuming very low power, or should be energy-autonomous. We tested and analyzed different system component choices to devise a system satisfying all these criteria.

A. Receiver

In this work we were focused primarily on the receiver, to adapt it to work in an energy-autonomous manner. Figure 2 shows the circuit diagram of the receiver, in which the solar panel and the capacitor are the main components to be tested and analyzed.

1) Indoor Solar Panel

In order to make an effective choice, it is important to take into account the key solar panel parameters such as cell efficiency. Cell efficiency depends on manufacturing technology, and involves aspects such as spectral sensitivity, light source and power density. In addition, the voltage range a solar panel provides is also important for its compatibility with the rest of the system components. In our receiver system, the active components require at least 3.6V. Finally, the frequency response characteristic, in terms of peak-to-peak voltage (V_{pp}), is crucial for the choice of modulation frequency of the OOK signal.

In this work, we evaluated three solar panels designed for indoor lighting. First one is a solar module consisting of 8 crystalline silicon solar cells, especially optimized for indoor lighting conditions provided by IMTEK Research Institute. It provides a maximum open circuit voltage of around 5.36V, with cell size of 4.8cm x 3cm and less than 0.1cm of thickness. The other two solar panels are off-the-shelf panels manufactured by Blue Solar, and are built with amorphous

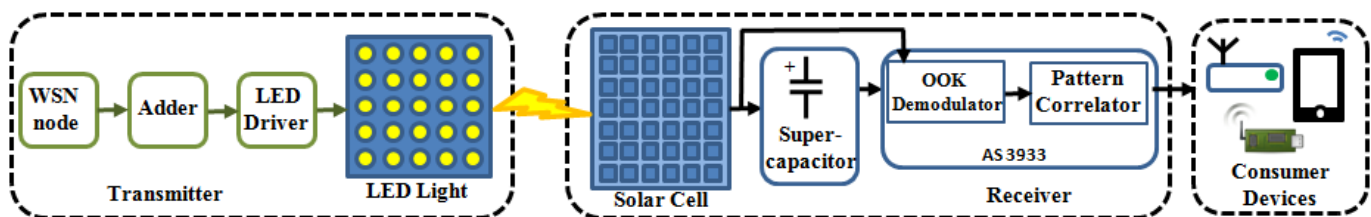

Fig. 1. Global system view of the energy-autonomous VLC wake-up system.

silicon solar cells. The differences between the last two are the size and the open circuit voltage, the SC3726I-8-1 (Small Off-the-shelf) has a rectangular shape of 3.6cm x 2.6cm and 0.1cm of thickness and around 6.24V of maximum open circuit voltage; while the SC5375I (Large Off-the-shelf) has also a rectangular shape, but with the dimensions of 7.5cm x 5.3cm x 0.1cm providing around 5.9V of maximum open circuit voltage.

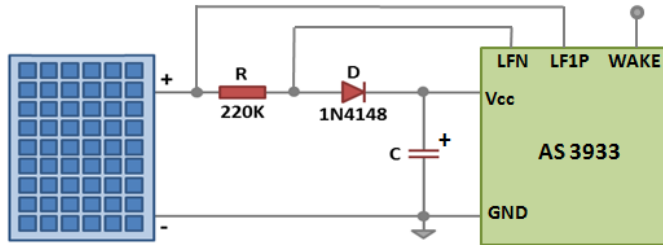

Fig. 2. Circuit diagram of the wake-up receiver.

In order to analyze the frequency response characteristics of these alternative indoor solar panel options, we performed the first set of tests varying the frequency within the range of 100Hz to 48.35 kHz. For the tests, a 10W LED is used locating the solar panels at a distance of 1m from the LED and disabling other types of light sources. The LED is powered with a voltage of 31V, resulting in a light intensity of approximately 158 lux at the solar panel location as measured by a lux meter. The results of the frequency response measurements are shown in Figure 3, relating the light OOK frequency with the relative voltage ($V_{relative}$). The relative voltage corresponds to the ratio between the absolute peak-to-peak voltage of the solar panel output signal at each frequency and the direct current (DC) average voltage of the respective solar panel. The DC average voltage is measured using an oscilloscope connected to the solar panel and programming the transmitter to generate continuous light.

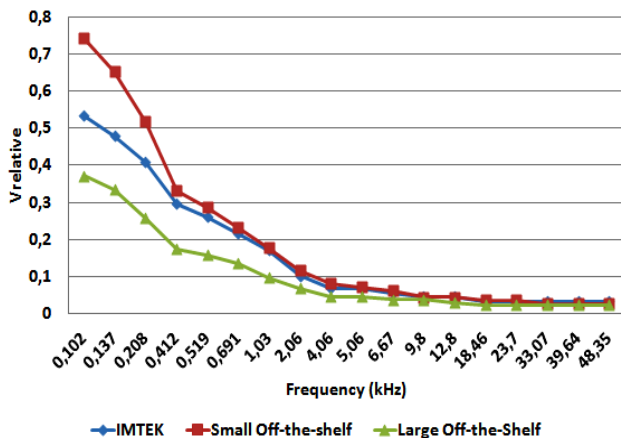

Fig. 3. Indoor solar panel responses to different frequencies.

As seen in Figure 3, in general all three solar panels provide better relative voltage values at low frequencies than at high frequencies [10]. For frequencies higher than 30 kHz the relative voltage values become too low. However the Small Off-the-Shelf solar panel has the highest relative voltage for almost all the range of frequencies. While the other two solar panels keep a quite similar response to each other, the

IMTEK solar panel just has slightly better relative voltage values compared to the Large Off-the-Shelf solar panel.

The IMTEK indoor solar cell delivers an efficiency of 16% at an illumination intensity of 100 lux, which is up to 6 times higher compared to commercially available indoor solar cells. However, the focus of this paper is dedicated to the frequency response of the solar cells which has not been an objective in solar cell technology. Therefore, in this paper the frequency response of solar cells rather than their efficiency is a key aspect.

Since the Small Off-the-Shelf and the IMTEK solar panels are the smallest in terms of size, and their cell areas are very similar, we choose the Small Off-the-Shelf solar panel as the best option to include in the receiver, due to its good frequency response and its small size.

The Small Off-the-shelf solar panel provides an open circuit current of $34.6\mu\text{A}$, and as shown later, this value is higher than the current consumption required by the receiver. In addition, according to the analyzed results of frequency response and the operational frequency range supported by the components, the frequency of 21 kHz was chosen as the operating frequency.

2) Rx Power Requirements and Power Storage Solution

To find an autonomous power solution for the receiver, the active components, i.e. the components requiring power should be assessed. For that, we need to know the operational voltage range and the current consumption of the components for different operational modes.

One active component of the receiver is the pattern correlator. After considering different pattern correlator design options, an off-the-shelf, low-power correlator and wake-up interrupt generator, AS3933 [8], is decided to be used in this system due to its lower power requirements compared to the other possible solutions. The AS3933 can detect any carrier signal with a frequency between 15 kHz and 150 kHz and modulated with On-Off Keying (OOK). Moreover this device includes an integrated data correlator that can detect a 16-bit or 32-bit Manchester coded programmable wake-up pattern. In addition, OOK modulation with Manchester code is one of the methods incorporated in IEEE 802.15.7 VLC standard [12].

In terms of power, the AS3933 consumes about $5.7\mu\text{A}$ when the three channels are in listening mode, and its operating voltage range, for detecting frames and generating wake-up signals, is between 2.4V and 3.6V. In addition, between 0.6V and 2.4V the AS3933 is not capable of generating wake-ups, yet its configuration is retained. Taking these values into account, the possibility of using a capacitor to feed the AS3933 chip was analyzed. A normal electrolytic capacitor with a capacity of $470\mu\text{F}$ and maximum voltage of 6.3V along with a super-capacitor of 1F and 5.5V were selected for tests. An important characteristic of capacitors is their power leakage. For that, we charged the capacitors to 3.6V (AS3933 maximum operating voltage) and measured the voltage level each 5 minutes during 1 hour. Also to perform this test it is important to reduce, as much as possible, the

influence of the measuring tool on discharging the capacitors, therefore it is required to select the highest input resistance measuring tool. Figure 4 shows the results of the voltage leakage tests using an oscilloscope with an input resistance of $1M\Omega$.

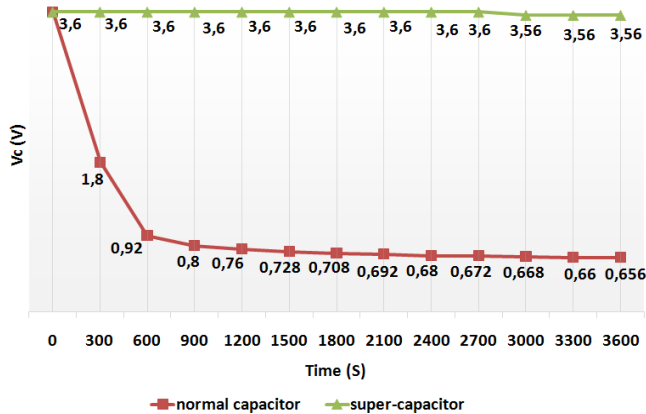

Fig. 4. Leakage test results for the electrolytic capacitor of $470\mu\text{F}$ and super-capacitor of 1F .

As expected, the leakage rate of the super-capacitor is much lower than the electrolytic capacitor, which is also related to the capacity of the capacitors. As seen in the figure, the electrolytic (normal) capacitor cannot offer the required voltage to generate wake-ups after 5 minutes, while the super-capacitor after that time just loses a few hundredths of its charge. Moreover, after almost 4 days without light to feed the receiver, the super-capacitor could keep the AS3933 configured and its final voltage was measured to be 2.2V . As this voltage level was very close to the minimum operating voltage of the AS3933, after turning-on the LED sending frames, the receiver could generate wake-ups shortly.

This verification allowed us to make sure that the receiver can be fed by a capacitor when lights are turned off, avoiding the use of batteries or other power source. For the rest of the system tests, we employed the super-capacitor.

To complete the evaluation of the power storage solution, a test to measure the charging time of the capacitors was also performed. During the test the LED was powered at 31.8V and the receiver was located at different distances and corresponding different light intensity values as measured by a lux meter. At the beginning of each test the capacitors were totally discharged (0V). The target voltage is the AS3933 minimum operating voltage (2.4V). Also a time limit was set at 5 minutes (300 seconds) because it is reasonable limit for real scenarios. The results of the test are shown in the Table 1. Note that, the light intensity level standard for general lighting at homes is 200lux [11].

The table shows the advantage of the normal capacitor over the super-capacitor in charging time. This means that the super-capacitor requires a higher current than the current supplied by the solar panel to be charged shortly. This feature becomes a drawback that must be solved in future works.

LI (lux)	Vstart (V)	normal capacitor		super-capacitor	
		Time (s)	Vend (V)	Time (s)	Vend (V)
50	0	300	0,528	300	0,002
100	0	300	0,92	300	0,004
200	0	300	1,4	300	0,006
300	0	300	2,28	300	0,01
400	0	100	2,4	300	0,014
500	0	60	2,38	300	0,018

Table 1. Charging time for an electrolytic capacitor of $470\mu\text{F}$ and super-capacitor of 1F from 0V under 300 seconds.

B. Transmitter

In the present work, the transmitter designed in [3] was adapted with several updates. The detailed schema of the transmitter is shown in Figure 5. The transmitter is composed of a Z1 low power wireless module from Zolertia [9], an adder, a LED driver and a 10W LED. Z1 is a low cost, small footprint programmable module that is used as modulator. Z1 can be configured, connecting a computer through its USB port, to compose a wake-up frame and modulate an OOK signal readable by the AS3933 at the receiver side. The modulated signal is delivered to the adder through three Z1 ports of 3V each. The adder performs the addition of the three input voltages, delivering a maximum of 9V to the LED driver when all ports are put at "1". The LED driver is mainly composed by a general purpose transistor working in switching regime, that drives the collector current and also the LED light according to the input OOK modulated signal.

Compared to the design in [3], a $15\text{k}\Omega$ resistor was included between the negative pin of the operational amplifier and ground, working in parallel with other $15\text{k}\Omega$ resistor. The new configuration of resistors improved the performance of the adder, providing better response at the output. Also, in the board in which the adder and the LED driver are built, a ground connection was included from the ground pin of the power supply that feed both circuits. The new connection improved the stability of the circuit and the system performance in general. Finally the way to power the Zolertia Z1 module from the USB connection was changed to the pin 23 of the port JP1B, applying 5Vdc from the power supply. This change enabled to use the USB port just for configuring the Z1 module. This, in turn, removed the USB ground connection from the computer; solving the anomalies in the transmitted signal caused by the different ground sources.

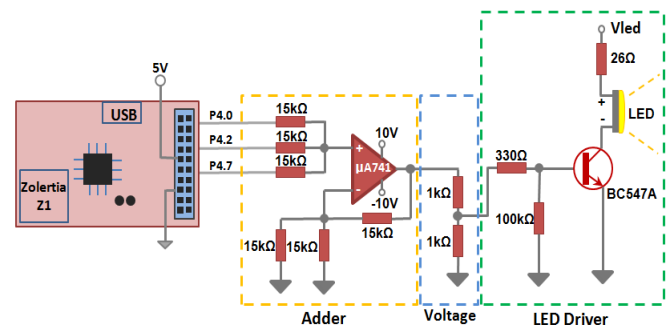

Fig. 5. Transmitter circuit diagram.

V. System Performance Evaluation

After making appropriate adjustments and selecting the necessary components to transform the VLC wake-up communication system into one using an energy-autonomous receiver, the system is tested for realistic indoor scenarios.

A. Effect of Distances and Angles

First, the crucial system performance metrics of operational distances and angles are evaluated. Accordingly, in the next test, the probability of detecting wake-ups was calculated by relating the number of wake-up calls generated by the receiver with a known amount of 50 wake-ups frames sent by the transmitter. The receiver was placed in a straight line relative to the LED at different distances where the LED, sending OOK wake-up frames, can provide light intensity levels similar to those levels standardized for an office and for home [11]. Also, at each point the solar panel was rotated to measure the wake-up probability with varying angles and distances, while the LED was powered with 31.8V. Table 2 shows the obtained values for this test. The table, measures at 0° corresponds to the position of the solar panel directly facing the LED, positive angles corresponds to the solar panel rotated to the right and negative angles corresponds to the solar panel rotated to the left.

D (m)	-90°		-45°		0°		45°		90°	
	LI (lux)	P (%)	LI (lux)	P (%)	LI (lux)	P (%)	LI (lux)	P (%)	LI (lux)	P (%)
1,56	4,7	78	22,6	76	50	96	31,9	6	6,1	90
0,87	6,5	30	82,8	92	200	92	106,8	88	8,2	8
0,45	16,7	70	337	92	700	94	370	88	21	0

Table 2. Probability of detecting wake-up signals and light intensity values with varying distances and angles on a straight line.

Regarding to light intensities, a value of 700lux was achieved at 0.45 being approximately the maximum required for an office. The standard for general lighting at home is 200lux and this value is measured at 0.87. However, 50lux were achieved at 1.56m, which corresponds to the minimum required for general illumination at home [11].

As expected, the probability of detecting wake-up signals varies when the solar panel is rotated at different angles, but also varies according to the distance when the solar panel is not parallel to the LED. At 0° the wake-up probability is high for measured distances up to 1.56m, i.e., for light intensity values between 50 and 700 lux. At extreme cases of rotating the solar panel at 90° and -90°, wake-ups were detected, however not in accordance with the distance, which may be due to the conditions of reflection for each position.

Then, the following set of tests was required to analyze more in depth the capabilities of the system. We located the receiver in different positions, inside an office room, varying the distances, angles and rotating the solar panel as in the previous test (from -90° to 90° in each position). The tests were performed with the room lights turned off, and testing LED light intensities controlled by the LED voltage of 31.8V. Several locations and angles tested within this office environment as illustrated in Figure 6. Table 3 shows the results of this test, which also include the received light intensity value for each position, measured with a lux-meter.

Note that the angles in Table 3 are relative to the room and hence angles relative to LED depend on the location. In Table 3, measures at 0° corresponds to the position of the solar panel parallel to the LED, positive angles corresponds to the solar panel rotated to the right and negative angles corresponds to the solar panel rotated to the left.

Note that in most of the cases the probability of detecting wake-ups under the worst possible conditions is higher than the 50%, and even in certain positions the probability is close or higher to 90%. Other aspect to be analyzed is that, as in the previous test, sometimes the number of detected wake-ups does not correspond with the distance, keeping the same angle of rotation.

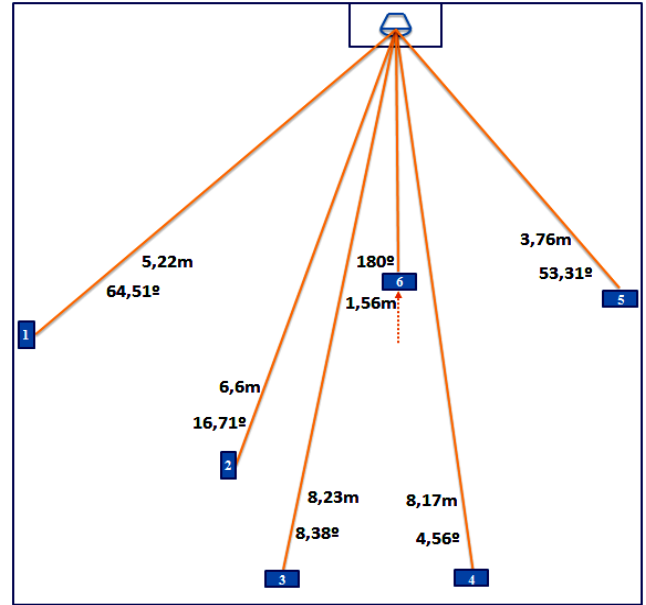

Fig. 6. Positions (distance and angles) tested with high probability of detecting wake-up frames.

Position	-90°		-45°		0°		45°		90°	
	LI (lux)	P (%)	LI (lux)	P (%)	LI (lux)	P (%)	LI (lux)	P (%)	LI (lux)	P (%)
1	0,7	62	0,7	52	1,4	70	3,2	90	21	72
2	1,7	64	2,2	64	4,9	92	3,8	88	35	70
3	0,6	60	1,6	80	3,1	60	2	70	29	62
4	0,9	62	2,4	60	3,5	60	2	38	7	14
5	4,9	88	5,9	86	4,3	80	2,1	54	30	60

Table 3. Probability of detecting wake-up signals and light intensity values with varying distances and angles at the locations of Figure 6.

The reason is that the system is able to detect reflected wake-up signals, and in some cases the probability of detecting wake-ups depends also on the conditions of light reflection of the position. Detecting reflections is an advantageous feature that increases the performance of the system even under unfavorable conditions. Light intensity measures helped us to know under which light level conditions the system can work. Analyzing the light intensity tests it is interesting to know that even for a light intensity of around 1lux, similar to a moonlit night, the receiver is able to work.

In addition, an extra test was done putting the receiver

facing opposite to the LED at 1.56m from de transmitter as illustrated in Figure 6 as position 6, where the receiver achieved a wake-up probability of 58%. This test indicates that the system is able to detect reflected wake-up frames, providing crucial flexibility for the potential user applications.

B. Effect of Light Interference

Another feature of indoor environments is the presence of interferences from other light sources. There are many types of light sources that may affect the quality of the transmitted signal such as lights powered with AC (alternating current) or LEDs powered with DC (direct current).

The first set of interference test was done using the office florescent lamp as an AC light source interferer and then in the second set of tests, another LED light is used as a DC light source interferer, powered at 28Vdc, located close to the transmitter LED and directed toward the solar panel. In both sets of tests the receiver is located at 1.50m from the LED transmitter and the LED brightness of the transmitter is varied, by varying the LED voltage between 25V and 31.8V, to test different light intensity differences between the transmitter and the interferer. The intensity of interfering AC light at the position of the solar panel was measured to be 183 lux, and 104 lux for LED interferer.

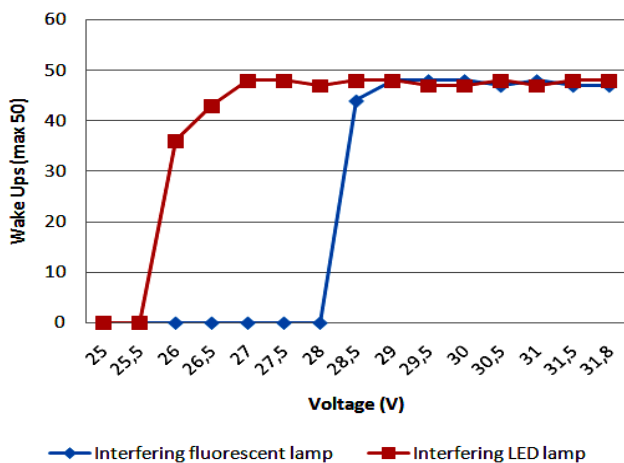

Fig. 7. Number of wake-ups generated for different LED voltage levels with interference from other light sources.

Figure 7 shows a large difference in behavior between the presence of fluorescent light interference and LED light interference. It can be seen in the figure that when using office fluorescent lamps, the system needs higher LED voltage, i.e., higher light intensity from the transmitter, to be able to have a good system performance in terms of wake-up probabilities.

A study of the AC fluorescent light waveform shows that, the signal received by solar panel, is nonlinear but oscillates at a frequency of around 100Hz. Therefore LED light must be strong to overcome the interference, as the LED signal and fluorescent light signals are mixed, the wake-up frames becomes more difficult to be detected by the AS3933.

On the other hand, using a similar LED lamp to introduce interference, a high wake-up probability is observed even varying the LED transmitter voltage from 25V to 31.8V. The LED interfering light has a linear waveform and it is not a

problem to the receiver to detect the wake-up frames when mixed with such interfering DC light.

Finally these tests show that the system can work in presence of other indoor light sources. Now it is known that the performance with DC light interference, like LEDs, is better than AC light interference, such fluorescent lamps. Even using fluorescent lamps the wake up frames can be received by readjusting the transmitter LED voltage or the distance.

VI. Conclusions and Future Work

In this study, a VLC-based wake-up communication system is derived and evaluated, where the receiver can work as an energy-autonomous system, using the solar panel as both VLC communication receiver and energy harvester. The system design tests were performed considering different solar panel and capacitor choices. The developed system built on the selected element options was evaluated in realistic indoor environments with varying distance, angles and with various interference sources. The results show good operational distances of this energy-autonomous receiver. A very interesting advantage noted in these tests is the possibility to detect reflected wake-up light signals, potentially eliminating the need for a direct line of sight between the LED and the receiver. A future work includes the evaluation of and solutions for sunlight interference and the analytical modeling of the energy behavior of the developed system.

References

- [1] Key World Energy Statistics 2014, International Energy Agency, 2014.
- [2] J. Oller, I. Demirkol, J. Casademont, J. Paradells, G.U. Gamm, L. Reindl, "Has Time Come to Switch From Duty-Cycled MAC Protocols to Wake-Up Radio for Wireless Sensor Networks?," *IEEE/ACM Transactions on Networking (available online)*, vol.PP, no.99, pp.1,1, 2015.
- [3] C. Carrascal, I. Demirkol, and J. Paradells, "A novel wake-up communication system using solar panel and Visible Light Communication," *2014 IEEE Global Communications Conference (GLOBECOM)*, pp.461,467, 8-12 Dec. 2014.
- [4] I. Demirkol, C. Ersoy and E. Onur, "Wake-up receivers for wireless sensor networks: benefits and challenges", *IEEE Wireless Communications*, August 2009.
- [5] J. Mathews, M. Barnes, A. Young and D. K. Arvind, "Low power wake-up in wireless sensor networks using free space optical communications", *4th Int. Conf. on Sensor Technologies and Applications*, 2010.
- [6] T. Häkkinen, J. Vanhala, "Ultra-low power wake-up circuit for short-range wireless communication", *IET 4th International Conference on Intelligent Environments*, 2008, Seattle, WA, United States.
- [7] M. Magno, N. Jackson, A. Mathewson, L. Benini and E. Popovici, "Combination of hybrid energy harvesters with MEMS piezoelectric and nano-Watt radio wake up to extend lifetime of system for wireless sensor nodes", *ARCS 2013*.
- [8] AS3933 - 3D Low frequency wakeup receiver. Datasheet. Austriamicrosystems. Revision 1.0. 2010
- [9] Zolertia datasheet, v1.1, March 11, 2010.
- [10] K. Sung-Man and W. Ji-San, "Simultaneous reception of visible light communication and optical energy using a solar cell receiver," *International Conference on ICT Convergence (ICTC) 2013*.
- [11] ISO 8995-1:2002(E)/CIE S 008/E:2001: Joint ISO/CIE Standard: Lighting of Work Places - Part 1: Indoor.
- [12] S. Rajagopal, R.D. Roberts and S. Lim. "IEEE 802.15.7 Visible Light Communication: modulation schemes and dimming support". *IEEE Communication Magazine*, Topics in Standars, March 2012.